

DIRECT DRAW KEG REFRIGERATORS

EBD – Series • EBD1 • EBD2 • EBD3 • EBD4



▲ EBD1



▲ EBD2



▲ EBD3



▲ EBD4

Cabinet Construction

Heavy duty stainless steel countertop and rail, textured and laminated black vinyl exterior. Galvanized steel interior wall, and high quality stainless steel floor. 1 3/4" thick high density foamed-in-place polyurethane insulation. Pre-installed four 4" diameter casters for single door unit. Built-in caster thread receptacles for all units.

Refrigeration System

- Back mounted condensing unit for single door, and side mounted condensing unit for two and three door models
- Oversized condenser and evaporator coils quickly achieve and maintain desired temperature
- Forced-air cooling with oversized evaporator fan motors provide balanced airflow throughout cabinet to ensure faster temperature drop
- Removable side panel and slide-out condensing unit for convenient repair and maintenance
- Environmentally friendly CFC free R-134A refrigerant
- Air defrost controlled by electrical timer
- Copper tube and aluminum fin evaporator with anti-corrosive coating
- Energy efficient condensate drain pan assembly heated by high side copper tube
- Pre-wired and ready to plug, 115V/60Hz/1Ph, NEMA 5-15P

Lighting

- Shielded incandescent interior lighting with on/off switch (not applicable to EBD1 models manufactured prior to 2017)

Doors

- Textured and laminated black exterior with galvanized steel interior
- 1 3/4" thick high density foamed-in-place polyurethane insulation
- One piece snap-in magnetic door gaskets for easy replacement
- Heavy duty recessed door handles
- Door locks

Draft Arms

- NSF approved 3" diameter insulated stainless steel draft arm with air distributor
- One draft arm for model EBD1, two draft arms for two and three door models

Temperature Control

- Factory preset temperature, 35°F
- Temperature setting range from 32°F to 42°F
- Easy to set analog thermostat

Options

- 2 1/2" and 4" diameter casters (3 1/2" and 5" overall height) optional for all models except EBD1
- Dual faucet towers



Dimensions

Side View (all models except EBD1)

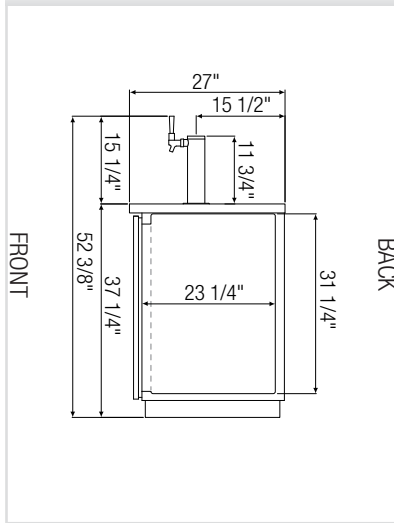

Side View (EBD1)

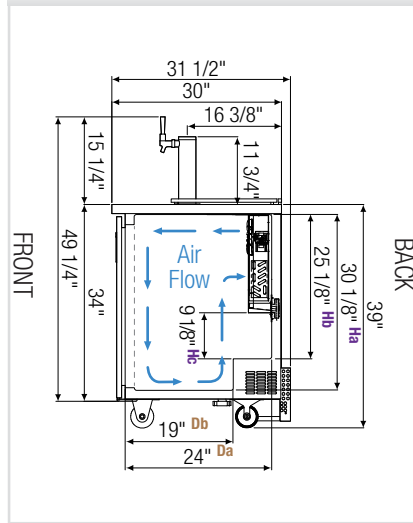

√ : Drain

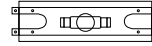

T-Shaped PVC Drain Fittings w/ Movable Plug.

It is required to use a hose attachment w/ 3/4" inner diameter.



Equipped with 9 ft long NEMA 5-15P plug.

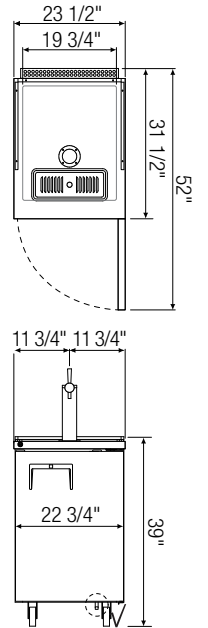

▲ EBD1

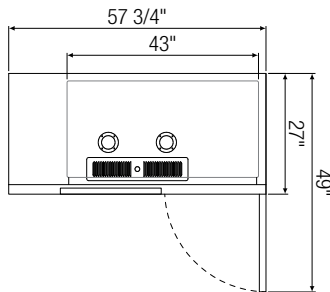

▲ EBD2

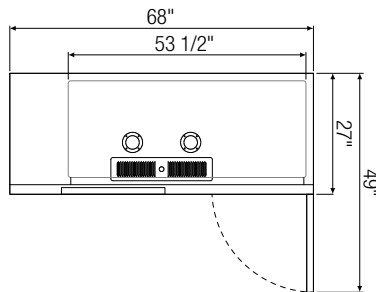

▲ EBD3

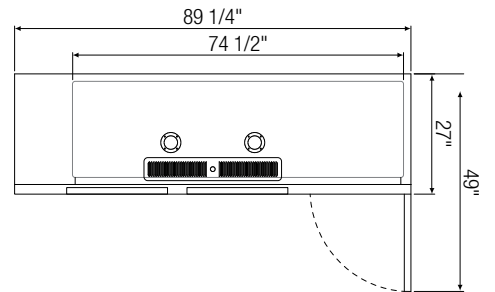

▲ EBD4

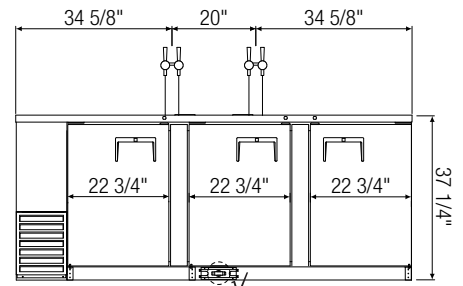
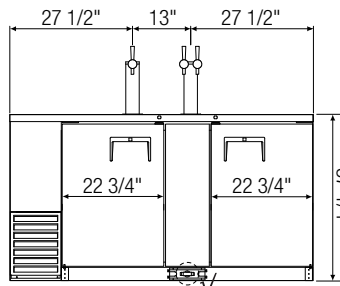
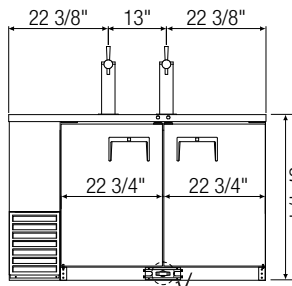

Model	Ref/ Frz/ Dual	# of Doors	# of 1/2 Barrels	Capacity (Cu.Ft.)	HP	Refrigerant	BTU/HR [†]	Power (V-Hz-Ph)	Amps	Crated Weight (LBS)	Exterior Dimensions (Inches)		
											L	D	H
EBD1	Ref	1	1	8.26	1/5	R-134A	1,741	115-60-1	3.90	160	23 1/2	31 1/2 ^a	39 ^b
EBD2	Ref	2	2	20.09	1/4+	R-134A	2,075	115-60-1	4.50	275	57 3/4	27	37 1/4
EBD3	Ref	2	3	24.01	1/4+	R-134A	2,075	115-60-1	4.50	313	68	27	37 1/4
EBD4	Ref	3	4	32.37	1/3	R-134A	2,555	115-60-1	4.50	363	89 1/4	27	37 1/4

†: Based on evaporating temperature of 23°F (-5°C) & condensing temperature of 131°F (55°C).

a: Depth includes 1 1/2" for back grill.

b: Height includes 5" for casters.

Da, Db : Interior Depth Ha, Hb, Hc : Interior Height

Ref = Refrigerator

Specifications subject to change without notice.

Product dimensions are for general purposes and not absolute value. Product capacity(▶) is calculated based on standard industry figures. Slight variations may exist. If dimensions and capacity are critical, please contact Everest Refrigeration.



Please visit our website for updated Energy Efficiency information.